

System Telephone ST 31



AGFEO

einfach | perfekt | kommunizieren

User Instructions

The digital System Phone ST 31 is intended for the connection to an internal S0-Bus of an AGFEO ISDN Telephone System. The ST 31 may be connected to the following AGFEO ISDN Telephone Systems:

- AS 151, AS 181, AS 1x, AS 2x from Firmware 6.3
- AS 281 All-In-One, AS 35, AS 35 All-In-One from Firmware 7.6
- AS 40 P (P400-1), AS 4000 (P400-1), AS 100 IT (P400 IT), AS 43, AS 45, AS 200 IT from Firmware 7.6
- all other AGFEO Telephone Systems with a Firmware below 7.1 will emulate the ST 31 as an ST 30 System Phone. Please refer to Page 18 for a description of function changes.

The AGFEO ST 31 System Phone will have a max. power consumption of 1.7 Watt when under full load, such like all LED's are lit, optional answering machine module A-40 installed and the phone ringing at full volume. The max. output for a S0 540 (S0440) module is 4.5 Watt for each two ports combined. This would mean that in the worst case scenario two ST 31's and one ST 30 (max. 1.3 Watt) could exceed the maximum limit set. This could activate the overload protection circuit and shut down the power supply to the relevant combined ports. (System Phones none functional / S0 Bus no power. Power will be restored after system reset) In such eventualities it is suggested to connect an external power source to the ISDN Bus.

A power supply unit may be obtained from your distributor, AGFEO Ref. No. 1542431. (Identical to STE 30 / DECT S0 Base Power Supply Unit)

Information regarding software upgrades are available via your dealer.

AGFEO will not accept any liability for damages which may result from improper use of the digital System Phone ST 31.

Safety Notice

- Do not work on the extension wiring or connect/disconnect the ST 31 during a thunder storm.
- Install extension wiring of the ST 31 in a manner that it is not walked on or causing anybody to trip over them.
- Ensure that no liquids are allowed to enter the housing of the ST 31 Digital System Phone as otherwise short circuiting may result.

About this User Guide

This User Manual is valid for the current system firmware available at the time. However, the ST 31 System Phone is controlled from the Telephone System, which means that if the system firmware is changed, then some sections in this manual may become invalid.

This manual contains user instructions for the ST 31 and a brief instruction regarding the system features. A detailed description of features relating to the Telephone System can be found in the accompanying user guide delivered with the Telephone System.

System Telephone ST 31

Table of Contents

Safety Notice	2
About this User Guide	2
User Instructions	2
Table of Contents	3
View of Base	4
Untangler Connection	4
Display Position	5
Registration	5
Connection	5
Buttons	6
Status Display	7
Using the Menu/ Status Display	7
Function Buttons - Freely programmable Function Buttons (overview)	8
LED - Display for freely programmable function buttons	10
Button Assignment	12
Changing Button Assignment	12
"Direct Line" Disabled	12
"Direct Line" Enabled	12
Call Waiting	13
Reject the Waiting Call	13
Initiate Call Back when free	13
Call Pick Up from Answering Machine	13
Incoming Call Pick Up	13
Display Call Log	14
Do Not Disturb (DND) Programming and Setting	14
Select Retrieval of Phone Book Entries	14
Telephone Book (Numeric)	14
Recent Numbers Redial	15
Automatic Redial	15
Phonebook (Alphabetic retrieval)	15
Phonebook (Vanity retrieval)	15
Location	16
Cleaning	16
Insert Button Designation Strip	16
DHSG Headset (Cordless Headset)	17
Connection of Headset	17
DSHG Headset Operation	18
ST 31 Firmware Upgrade	18
Change of Operation in Emulation Mode	18

System Telephone ST 31

View of Base

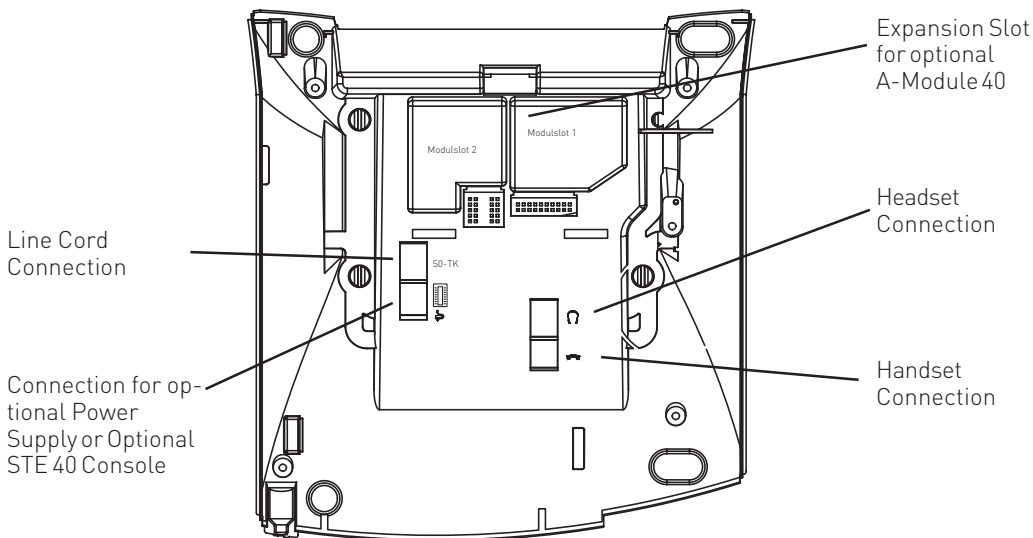

Untangler Connection

The ST 31 handset offers a compartment for the connection of a cord untangler. As the optional untangler is fitted inside the handset it will not interfere in normal use or when the receiver is put back on hook.

- to open the handset cover, press the lid (arrow 1) and remove lid (arrow 2).
- unplug the handset cord from the handset.
- connect the untangler to the handset.
- connect the handset cable to the untangler.
- close the lid

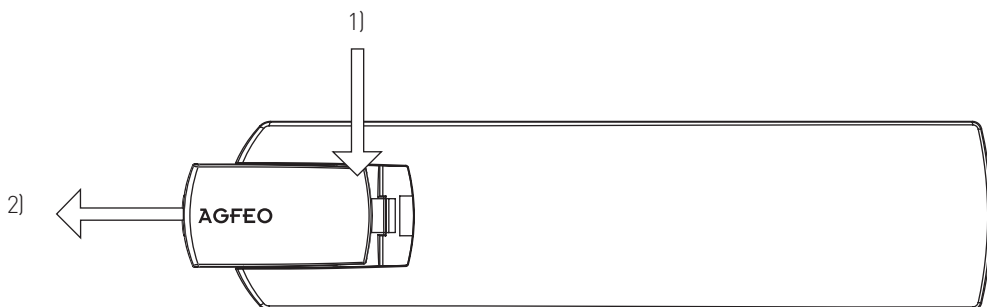

System Telephone ST 31

Display Position

Your Display can be adjusted to 6 different viewing angles.

Connection

Connect the line cord of the ST 31 into the ISDN telephone socket which is connected to the internal ISDN line of your AGFEO Telephone System.

- insert the RJ 45 plug into the socket until you hear a positive click.
- to release the plug, press the release latch on the plug and at the same time pull the cable out of the socket. (use a small screw driver if required)

Please note that the S0 Bus must be terminated with two 100 Ohm ¼ Watt Resistors.

Registration

An extension number will be allocated automatically from the telephone system to the ST 31 once it is connected to the system, ie plugged into the ISDN telephone socket. If the phone is connected for the first time to the system then it will have to be registered to it. Please follow the instruction in the display of the phone. It may be useful to allocate an extension number to the ST 31 before this is connected to the system by using TK-Suite Set the computer based programming tool.

System Telephone ST 31

Buttons

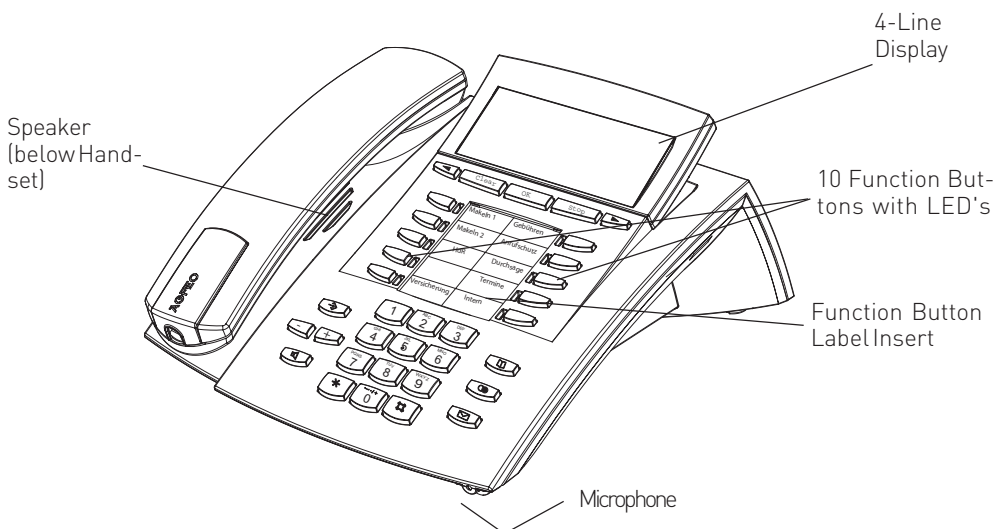

1 0 Numeric Keypad

* # * and # Buttons

→ Set Button - Start and end programming. Keep this button pressed to toggle between programming tree and programming index

📞 Handsfree Button - Activates the Loudspeaker. Button lights up when in use.

◀ ▶ Arrow Buttons - To scroll through the display if there is more than one function available.

📖 Phone Book Button - Retrieval of Telephone Numbers.

📞 LNR - Last Number Redial Button. Keep this button pressed to show call log.

✉ Message Waiting LED - Flashes on new entry in the call log or missed call. Permanent lit for numbers already viewed. Clears when number is called or deleted from list by pressing clear button

Clear Clear Button - Clear an entry

OK OK Button - Confirms Entry

Stop Stop Button - disconnect or cancel an action

10 function Buttons - User programmable, two entries per Button (First & Second Level) Keep this button pressed for approx 1 sec. to show the second level. LED indication only for first level.

± Plus and minus for volume adjustment of handset or speaker.

System Telephone ST 31

Status Display

Status display of internal and external SO Bus and analogue lines

Extension Numbers will be displayed if they are off hook or ringing.

```
UK43 Fr 27.Oct.06 11:52
xIXIA- *?C#05
13 15 17 18 23 24 30 32
41 52
```

Display of enabled features.

1. Display Line: Date & Time

Index of functions:

- | | | | |
|---|--|----|---------------------------------------|
| ✕ | External ISDN-Line. One line (a B-channel) is busy. The "x" is shown inverted on an external call. | ☎ | Diversion/ISDN-call forwarding active |
| i | Internal ISDN-Line. One Line (a B-channel) is busy. | € | CVA 2 (Night service) on |
| A | Analogue trunk line. The "A" is shown inverted on an external call | 🔒 | Phone lock on |
| | Features: | ⏰ | Wake-up on |
| | Browse with ◀▶, Confirm with „ok” | Ⓟ | Appointment on |
| ⏸ | Call-Waiting off | S | Sensor activated |
| * | Do Not Disturb on | F | Filter activated |
| | | I | Withhold own number |
| | | PC | PC Programming in process |

Using the Menu/ Status Display

Please pay attention to the display when using the phone; it will guide you through all available user options. Should the Context Menu be enabled (default setting) then you may select from other functions which will be offered to you in the last line of the display, either before answering a call or during a call.

Selectable features are:

Answer, Park Call, Retrieve, Call Pick Up, Call-Split, Transfer, Call Back, Conference, Enquiry, Reject, Disconnect, Deflect to, Back, Completed and Door-Opener.

The frequently used functions will be offered first. You may browse for additional features, if available by using the arrow buttons ◀▶. To select the displayed function press OK.

System Telephone ST 31

Function Buttons - Freely programmable Function Buttons (overview)

TAM activation	To switch answering machine on or off (optional module)
TAM info	To listen to recorded messages.
TAM Memo	To record memo on the TAM
Reject	Reject an incoming call. Caller will hear busy tone.
Call Waiting Enabled / off	You can select if: Set to off busy tone will be returned if the extension is on another call or off hook. A waiting call should only be visually indicated on your phone. (set to visual) Or if a call waiting tone should also be signalled. (set to audible)
Call Deflection	Will divert an incoming call during the ringing phase. There will be no change to the ringing tone when diverted. The caller will not be aware that the call was forwarded.
Call Filter	To switch Call Filters on or off.
Call Log	Will list unanswered in the Call Log
Cleaning	In connection with the check in / check out button. This can be used to indicate to the front desk that a room has been cleaned and is ready for occupation.
Do not Disturb (DND)	This will disable the Tone Ringer Special function buttons may be set: DND for internal calls DND for external calls DND for internal- and external calls.
Night Service (AVA 2)	Night Service on or off. Special function buttons may be set: Night Service can be switched for each trunk line. Night Service can be switched for all trunk lines.
Call Forwarding	Enable / Disable Call Forward if designated extension does not answer an incoming call. Special function buttons may be allocated: Switch Call Forward for each trunk line. Switch Call Forward for all trunk lines.
Tannoy	Announcement via Public Address Amplifier connected to the Telephone System
Busy on Busy	Returns Busy Tone to Caller if one Extension is Busy within Call Distribution Group. Special Buttons can be assigned -Busy on Busy for each Call Distribution Group switchable separately -Busy on Busy for call Call Distribution Group switchable together
Call by Call	To select Network Provider via LCR
Check In/ Check Out	Check in / Check out for Hotel applications. Will start or stop call logging and switch on or off trunk line access.
Page (Tannoy)	Pageing Announcement to System Phones. Programmable function Button - Page specific Extensions.
Units	Display Call Cost
Call Capture	Malicious Call Identification via ISDN-Exchange
Remote functions	Sending of stored DTMF Tones (1..0 * #) for a remote interrogation of a Telephone Answering Machine (TAM)
Remote Answer	To pick up another ringing extension.
Group Button	Log in or out of Groups and features
Headset	To use a Headset (only Digital System Phones)
Mute Button	To mute microphone on your telephone.

System Telephone ST 31

Function Buttons - Freely programmable Function Buttons (overview)

Call Pick Up	To Pick Up a call ringing on another extension. A Special Function Button may be assigned for this feature.
Withhold	To withhold own number being forwarded to the number called.
Internal Button	To Dial Extensions. Function Button can be assigned to call specific Extension (DSS)
ISDN-Hold	To Hold an external call in the Telephone Exchange (only available on PTMP ISDN lines)
ISDN-Call Forwarding	To set or cancel the ISDN Call Forwarding feature.
Conference	To set up a Conference Call with Internal and or External calls.
Speaker Volume	To adjust Speaker Volume for Handsfree or On Hook use.
LCR	To set or cancel Least Cost Routing (LCR) on your System Phone.
Call Split	To talk to more than one Call in turn without connecting them.
Brokers Call	To talk to one internal and one external call at a time without connecting them.
External	To select a specific number to make an outgoing call on. A function button may be assigned for this feature.
Relays	To activate a Relays. A special function Button may be assigned.
Reserve	To reserve a line should all lines be engaged at the time. (Call Back when free)
Sensor	To Enable or Disable Sensors.
SMS info	Will list all saved SMS messages
Write SMS Message	To write a SMS message.
Enquiry Call	To establish or set up an Enquiry Call
Telephone Book	To select a number out of the System Telephone Book
Telephone Lock	To Lock the Phone. Emergency and direct numbers may be dialled if set.
Appointment	To set or cancel a preset Appointment Time
Timer	To switch on or off a Timed based function, such as Day-Night Service, Call Forwarding, Relays etc. Buttons can be assigned for this function. 20 Multi Function Timers are available.
Doorphone and Lock Release	Function Button can be assigned to connect to the Doorphone. A separate Button can also be assigned to activate the Lock Release.
Transfer	To transfer and connect an external call to an external call.
Diversion from (Follow me)	To divert all calls from another phone to the current phone used.
Diversion to	To divert all calls to another extension- or external number.
Wake Up	To set or cancel a Wake Up Call
Destination Button	To Call a preset Telephone Number
- Public	- A number is stored in the Telephone System Memory
- Private	- A number is only stored in your telephone

System Telephone ST 31

LED - Display for freely programmable function buttons

	LED on	LED off	LED flashes
Answering Machine Messages	Stored messages already listened to.	No Messages	New Messages
Call Waiting activation	enabled	disabled	
Call Log	Call Log entries already viewed	No numbers in Call Log	New Numbers in Call Log
Do Not Disturb	on	off	
Night Service	on	off	
Call Forwarding	set	off	
Busy on Busy	on	off	
Group Button	Logged in	Logged out	
Headset	active	off	Incoming Call
Withhold Number	on	off	
LCR	on	off	
Relays	on	off	Relay is being rung
SMS Info	Messages already read	No Messages	New Messages
Mute Button	enabled	disabled	
Telephone Lock	on	off	
Appointment	set	off	when appointment call is ringing
Ringer Off	on	off	
Doorphone and Lock Release	connected to door phone	switched off	called from door phone
Diversion from	enabled	disabled	
Diversion to	enabled	disabled	
Wake Up	set	off	Unanswered Wake Up Call

System Telephone ST 31

LED - Display for freely programmable function buttons

	LED on	LED off	LED flashes (slowly)	LED flashes (fast)
TAM Activation	TAM switched on	TAM switched off		
Extension Button (DSS)	Extension Busy or off hook		The button is allocated to an answering machine ¹⁾ . If it has answered the call, then it can be picked up by pressing this button.	Exclusiv Hold.
Line Button	Line is in use	Line is available to make an outgoing call	Incoming Call	Exclusiv Hold. Call can only be retrieved by the original extension.
Timer Button	Timer is on, function is off	Timer and function is off	Timer and function is on	
Memory Dial Button		Goes off as soon as the call is answered	Flashes on incoming call from that number. Call can be picked up.	

General information regarding a Line Button.

To have a meaningful presentation of line buttons it is suggested to program two buttons for each ISDN line (2 B-Channels). By pressing a flashing line button when the phone is idle will give information of the waiting callers number. Pressing this button when the phone is off hook will connect to the call.

1) Only Answering Machines which are directly connected to an Analogue Extension Line.

System Telephone ST 31

Button Assignment

In default all System Phone Buttons are pre-programmed with the same functions.

Functions of each button can be changed to accommodate an individual application.

Announce	Call Waiting
System Memory	System Memory
Appointment	Tone Call
System Memory	System Memory
Call Filter	Mute
System Memory	System Memory
System Memory	Diversion to
System Memory	System Memory
System Memory	Internal
System Memory	System Memory

Changing Button Assignment



Start Programming



Enter PIN if required



Press Button to program



Enter first letter of function or browse using the arrow buttons.



Confirm Entry



End Programming

"Direct Line" Enabled

Calling an Extension:



Lift receiver



Dial # and Extension Number

Making an Outside Call:



Lift receiver



Dial Number

"Direct Line" Disabled

Calling an Extension:



Lift receiver



Dial Extension Number

Making an Outside Call:



Lift receiver



Dial 0 (or 9) for a Line. Wait for Dial Tone. Dial Number.

System Telephone ST 31

Call Waiting

First Option:

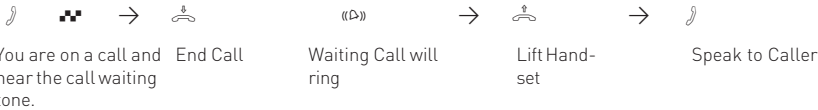

Second Option:



Press the Button "Call Split or Brokers Call". The first call is put on hold and you are connected to the second caller. You now can toggle between the calls or transfer the call.

Reject the Waiting Call



Press the Button "Reject". The caller will receive busy tone if you are the only Continue conversation ringing extension in the call distribution table. The caller will continue to hear a ringing tone if another extension is in the same call distribution table.

Initiate Call Back when free



Called extension is busy or does not answer your call

Press **OK**. Ring Back when free is initiated. Confirmation tone will be returned.

Replace Handset.

Incoming Call Pick Up



To pick up incoming call. Pick up Handset. Press **OK** to answer the call.

Call Pick Up from Answering Machine

Call Pick Up from an Answering Machine is only possible if the the port has been configured to "Answering Machine" via TK Suite.



Incoming call has been answered by the Answering Machine.

Lift Handset, **Press Button "Pick Up Call"**.
NOTE: Only possible if this button has been configured as a DSS button for that extension.

System Telephone ST 31

Display Call Log

The handset is on hook. The Message Waiting LED is flashing.

There will be at least one new entry in the Call Log. The Message Waiting LED will flash until the new entries have been displayed, after which the LED will remain lit until you return the call to the displayed number or delete the entry.

Press the message waiting button to display the first entry in the log .

The LCD will display the number, time & date, or a notification to return a call from an extension including time & date.

Further entries may be displayed by using the arrow keys.  

The number displayed will automatically be dialled by lifting the handset. The number logged will automatically be deleted once the call is answered. The number will remain in the call log if the call remains unanswered.

To delete an entry, select the required number and press .

To exit the call log display press .

Do Not Disturb (DND) Programming and Setting



 "1": DND from Extension Calls Only
"2": DND from Incoming Calls
"3": DND for both



Select the function with the **Button "Set"** and **Button "DND"**.

Exit programming

To set or cancel DND for the pre-selected condition press the DND button.

Select Retrieval of Phone Book Entries



Press and hold the Phone Book Button for 1 second



Select the desired setting with the arrow keys. (Vanity, Numeric or Alphabetical) confirm selection pressing .

Telephone Book (Numeric)



Press Phone Book Button Enter the required short code or use the arrow keys to browse to find desired entry.

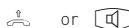

Pick up handset or press "Speaker Phone Button", the telephone number will be dialled automatically and the selected number will be displayed.

System Telephone ST 31

Phonebook (Vanity retrieval)



Press
Phonebook
button



Enter the first letter, ie. A=2. The first entry with this letter will be displayed



Select the next letter, ie M = 6. The first entry with "Am" will be displayed



Pick up handset or press "Speaker Phone Button". The selected entry will be dialled.

Browse with arrow keys  

Phonebook (Alphabetic retrieval)



Press
Phonebook
button



Enter the first letter, ie. A=2. The first entry with this letter will be displayed



Press the arrow button to move to the next character entry



Enter the second letter, i. e. N =66.



or



Pick up handset or press "Speaker Phone Button". The selected entry will be dialled.

Scroll with arrow buttons  

Recent Numbers Redial



With the handset on hook press the "RedialButton". The last dialled number will be displayed.



Use arrow buttons to select one of the last 10 numbers dialled.



or



Pick up handset or press "Speaker Phone Button". The selected entry will be dialled.

Automatic Redial



With the handset on hook press the "RedialButton". The last dialled number will be displayed.



Press  to start the automatic redial feature. The display will show how many attempts the system will try to connect to the number. The loudspeaker will be switched on as soon as a connection has been established.



or



Pick up handset or press the speaker phone button as soon as the caller has answered. Otherwise the call will be disconnected after 20 seconds.

System Telephone ST 31

Location

Select a suitable location for the ST 31 to be installed. Please observe the following points:

- Do not use locations where the phone could be subjected to water or chemicals.
- Rubber feet of the Phone:
Your phone has been manufactured for general use. Some chemicals found in furniture polish or other furniture care products may alter the substance of the rubber feet of the phone. Due to this influence it may be possible that the rubber feet of the telephone may leave some marks. We will not accept any liability for any of such occurrences. With reference to new furniture or polished furniture we would suggest to use a non-slip protective matt for your telephone.

Cleaning

To clean your telephone **use a soft damp cloth**. An antistatic cloth may also be used. **NEVER use a dry cloth** as this could result in a static discharge which may damage electronic components within the telephone. Please take great care that **NO MOISTURE** will enter the telephone as this will lead to malfunction and ultimately damage the telephone.

Insert Button Designation Strip

Your ST 31 includes a printed designation strip which shows the button allocation in default. You may use the reverse to enter your own designations.

Use a finger-nail between the upper end of the window and the phone casing. Pull the window downwards until it buckles. You can now take it out.

You can print corresponding labels on your PC, using the TK-Set configuration program.

Re-insert the window at the lower end and follow above instruction for removal in reverse order.

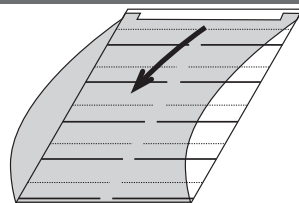

System Telephone ST 31

DHSG Headset (Cordless Headset)

The DHSG connectivity is a new industry standard which is supported by various headset manufacturers. This bi-directional connection makes it possible to deliver a high functionality between telephone and headset from different manufacturers. The telephone can signal to the headset via the DHSG connection if it is on - or off hook and if the telephone is ringing. Likewise the headset is able to signal to the phone if it wants to be on - or off hook. The condition will be that both devices, telephone and headset, are able to support this type of protocol.

Connection of Headset

The ST 31 has a separate RJ 45 headset connection. Instead of connecting the cordless DHSG Headset AGFEO 9120 you may also use some of the following corded headsets:

Manufacturer Model		Order No.
AGFEO	Headset 2100	6548839
	Headset 2200	6548847
Plantronics	Supra Monaural Polaris Modell P51 *	32190-04
	Tristar Modell P81 *	33695-01
	* including connection cable U10P	38058-01
GN Netcom	Profile monaural **	1861-15-03
	Optima NC monaural **	1913-29-01
	** Including connection cable	8800-00-01

The headset socket can be found underneath the ST 31 (See Page 4). The socket is marked with a headset symbol.

- insert the headset plug into the headset socket until you hear a positive click.
- lay the cable in the cable duct underneath the ST 31 which is also used as a strain relief
- to unplug the cable, release the latch on the plug (use a small screw driver if required) and at the same time pull the plug out of the socket.

Please note you may need an adapter from RJ45 to RJ 11.

System Telephone ST 31

DSHG Headset Operation

Please program a headset button for the ST 31 or STE 40 either via TK Suite Basic or the system programming code XX31.

- You now will be able to answer or clear a call for the headset.
Your headset will also ring in the earpiece once your telephone rings.
- You can answer the call by pressing the programmed headset button on the ST 31 or STE 40, or by pressing the button directly on your headset.
- If so required you may disable the ringer of the ST 31 but still will hear a call ringing directly in the earpiece of your headset. This will be ideal for call centres or open plan offices.
- If the caller hangs up, then the telephone system will also clear the call and the headset goes automatically on hook. There is no need to press a button on the ST 31 or the headset to go back on hook.

ST31 Firmware Upgrade

Your System Phone ST 31 can be upgraded to the latest firmware level without the need to change any hardware. To do so please follow the instructions below:

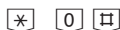

With the handset on hook the System Phone ST 31 is idle.

Press the buttons all at the same time. The ST31 is now in service mode.

Select Software Update by pressing the digit . If for any reason you do not want to continue with the update but want the phone to return to normal operation, then press digit 3 "Hauptprogramm" (Main Program).

Enter the telephone number of the Update Server
004952144709950
[Updateserver AGFEO Bielefeld]
If required enter access digit 9 if no spontaneous line seizure is set.:
9004952144709950

Confirm entry with middle soft button (ok). The Update Server will now be dialled and the update will start.

The update will be completed within approx. 90 seconds. The ST 31 will automatically re register to the telephone system. On start up the software level will be displayed on the phone. The update is now completed.

Change of Operation in Emulation Mode

All AGFEO Telephone Systems not listed in the User Instructions on Page 2 will recognise the ST 31 but emulate the operation of a ST 30 System Phone. Therefore the following ST 31 functions are amended:

- The „+“ and „-“ Buttons have no function when in emulation mode.
- Nine Function Buttons are available which are programmed in two levels, whereby the bottom right button is used as a „Shift“ key.
- The operation of both a DSHG headset and a A-Module 40 is not possible. However, the operation of either a DSHG headset or A-Module 40 may be utilised.

ST 30 features can be found in the User Manual of your Telephone System.

EU-Konformitätserklärung

EC-Declaration of Conformity
CE-Déclaration de Conformité

Der Hersteller: AGFEO GmbH & Co. KG

The Manufacturer:
Le Constructeur:

Adresse: Gaswerkstr. 8
D - 33647 Bielefeld

Address:
Adresse:

Erklärt, dass das Produkt: ST 31

Declares that the Product:
Déclare que le Produit:

Type: Systemtelefon

Model: ST 31

Components:

die grundlegenden Anforderungen gemäß Artikel 3 der nachstehenden EU-Richtlinien erfüllt:

meets the essential requirements according to article 3 of the following EC-Directive:
est conforme aux exigences essentielles d' article 3 de la Directive CE:

Richtlinie 1999/5/EG des Europäischen Parlaments und des Rates vom 09. März 1999 über Funkanlagen und Telekommunikationsendeinrichtungen und die gegenseitige Anerkennung ihrer Konformität

Directive 1999/5/EC of the European Parliament and of the Council of 09 March 1999 relating to radio and telecommunications terminal equipment, including the mutual recognition of their conformity
Directive 1999/5/CE du Parlement européen et du Conseil du 09 mars 1999 concernant les radio et équipement terminaux de télécommunications, incluant la reconnaissance mutuelle de leur conformité

und dass die folgenden harmonisierten Normen angewandt wurden:

and that the following harmonised standards has been applied:
et que les standards harmonisés suivants ont été appliqués:

EN 55022/2003
EN 55024/2003

Bielefeld, 18. Oktober 2006

Ort und Datum der Konformitätserklärung

Place and date of the declaration Lieu et date de la déclaration

Phone : +49(0)5 21 44 70 9-0
FAX : +49(0)5 21 44 70 9-50

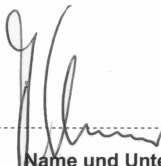

Name und Unterschrift

Name and Signature Nom et Signature

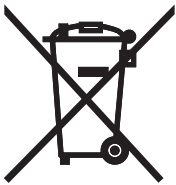

The crossed out wheeled bin on the product means that this belongs to the group of Electro- and electronic apparatus.

In this context you are directed by the European regulation to dispose of used apparatus
- at the point of buying an item of equal proportion / value
- at the local available collection point for disposal

With this you will participate in the reuse of material and valorisation of disused electric- and electronic apparatus, which otherwise could be a health hazard and be negative to the environment.



Ident no. 1101627

Subject to change without notice. No liability can be accepted for errors contained in this document.

Printed in Germany
0072

AGFEO GmbH & Co. KG

Gaswerkstr. 8

D-33647 Bielefeld

Internet: <http://www.agfeo.com>